

# Wellis®

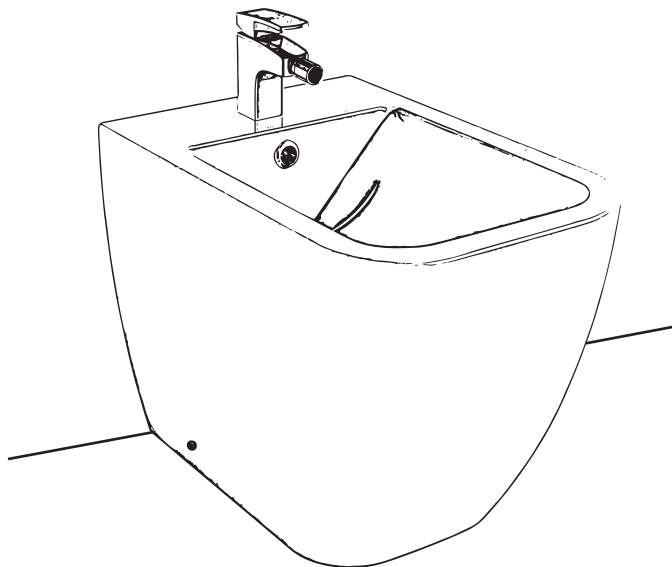

EN

**Ditte floor mount bidet**

INSTALLATION MANUAL

DE

**Ditte Bidet für Bodenmontage**

INSTALLATIONSANLEITUNG

FR

**Ditte bidet à fixation au sol**

INSTALLATION MANUELLE

HU

**Ditte padlóra rögzített bidé**

ÖSSZESZERELÉSI ÚTMUTATÓ

RO

**Bideu de pardoseală Ditte**

INSTRUCȚIUNI DE MONTARE

WF00024

**DITTE**

## Before Installation

- 1 Make sure the wall should be straight.
- 2 Read the instruction to be familiar with the tools, fittings and installation procedures to prevent any unnecessary damage.
- 3 Check the fittings follow the fitting form and check whether there is any damage of the product.
- 4 Because the ceramic is easy to be damaged, please handle it gently and the nut should not be over-tightened.
- 5 Make sure water supply has been turn off.

## Tools (not included)



Flat Screwdriver



Drilling machine



Silica gel



Spanner



Spirit level



Tape measure



Pencil

## Installation Procedure

- 1 Put the bidet onto the suitable position, and make the water outlet of bidet aligned with the drainage outlet.

Note : Preposition enough distance for connecting water supply pipe and drain pipe.

- 2 Mark the installing holes on the floor.
- 3 Remove the bidet carefully and drill holes according to the mark. Insert the expansible plastics or install 7# fixing plastic.
- 4 Install faucet ,water supply valve and drain units according to the installation instruction for fittings.
- 5 Put the bidet onto the suitable position, and get the water supply valve and the faucet connected with soft pipe. Then adjust the connecting bar.

Note : Water faucet is not supplied with this product.

- 6 Get the screw aligned with the plastic particle and fix the bidet onto the floor. Then cover the decoration cap.
- 7 Daub a layer of silicone between the bidet and the floor.
- 8 Finish the installation.

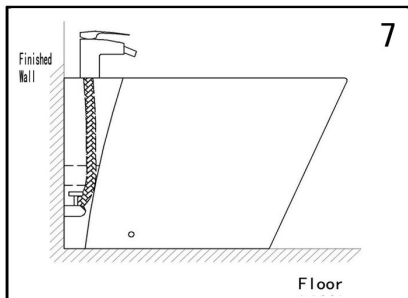
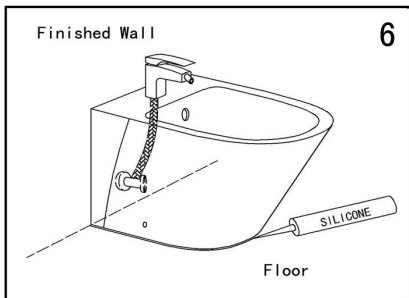
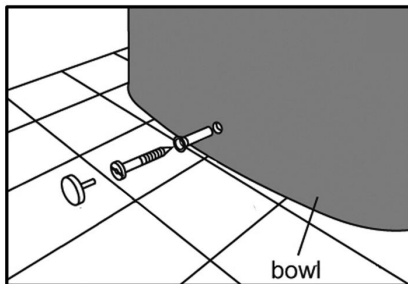
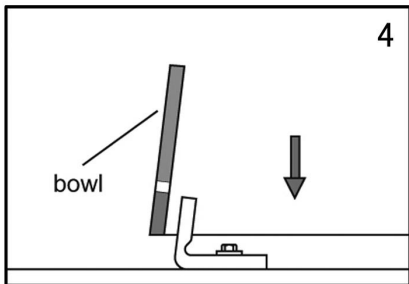
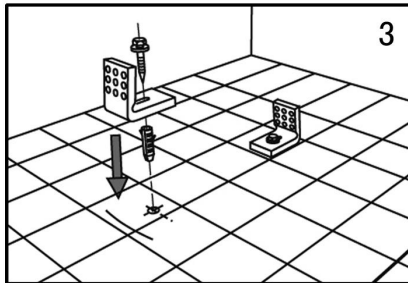
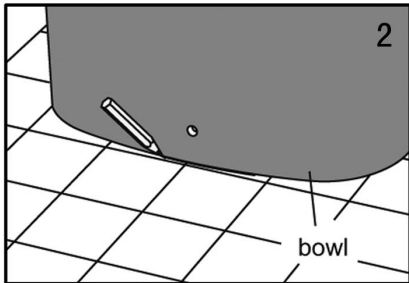
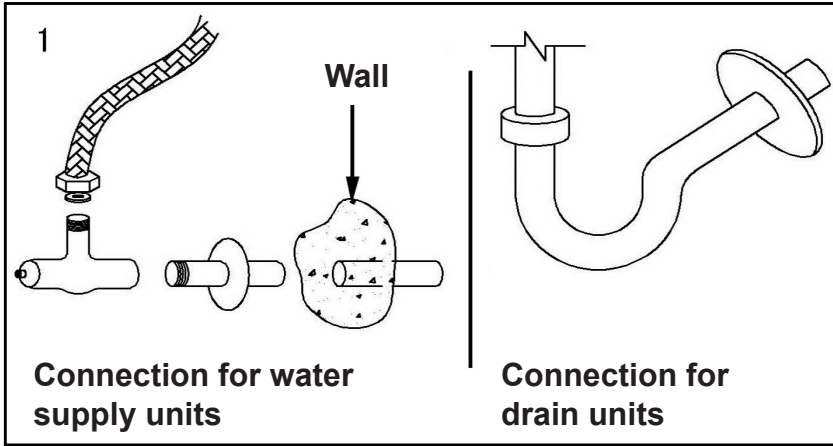

## Vor der Installation

- 1 Stellen Sie sicher, dass die Wand gerade ist.
- 2 Lesen Sie die Anleitung, um sich mit den Werkzeugen, Armaturen und Installationsverfahren vertraut zu machen, um unnötige Schäden zu vermeiden.
- 3 Prüfen Sie, ob die Verschraubungen der Verschraubungsform entsprechen und ob das Produkt beschädigt ist.
- 4 Da die Keramik leicht beschädigt werden kann, behandeln Sie sie bitte vorsichtig und die Mutter sollte nicht zu fest angezogen werden.
- 5 Stellen Sie sicher, dass die Wasserversorgung ausgeschaltet ist.

## Werkzeuge (nicht enthalten)



Flacher Schraubendreher



Bohrmaschine



Silicagel



Schlüssel



Wasserwaage



Maßband



Bleistift

## Installationsverfahren

- 1 Bringen Sie das Bidet in die geeignete Position und richten Sie den Wasserauslass des Bidet mit dem Abfluss aus.

Hinweis Stellen Sie genügend Abstand für den Anschluss der Wasserversorgungsleitung und der Ablaufleitung vor.

- 2 Markieren Sie die Installationslöcher am Boden.
- 3 Entfernen Sie das Bidet vorsichtig und bohren Sie die Löcher entsprechend der Markierung. Legen Sie den Spreizkunststoff ein oder installieren Sie den 7#-Befestigungskunststoff.
- 4 Montieren Sie den Wasserhahn, das Wasserversorgungsventil und die Ablaufeinheiten gemäß der Installationsanleitung für die Armaturen.
- 5 Bringen Sie das Bidet in die geeignete Position und bringen Sie das Wasserzufuhrventil und den Wasserhahn mit einem weichen Rohr in Verbindung. Stellen Sie dann die Verbindungsstange ein.

Hinweis : Wasserhahn wird nicht mit diesem Produkt geliefert.

- 6 Bringen Sie die Schraube auf die Kunststoffpartikel und befestigen Sie das Bidet auf dem Boden. Bedecken Sie dann die Dekorationsskappe.
- 7 Tragen Sie zwischen Bidet und Boden eine Silikonschicht auf.
- 8 Beenden Sie die Installation.

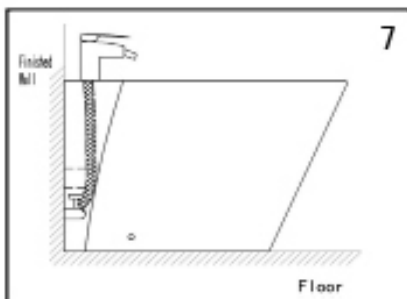
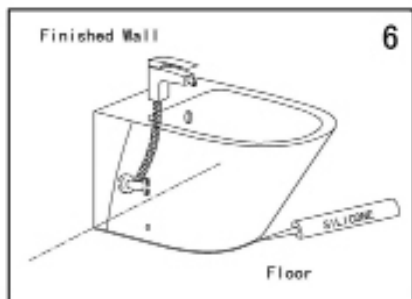
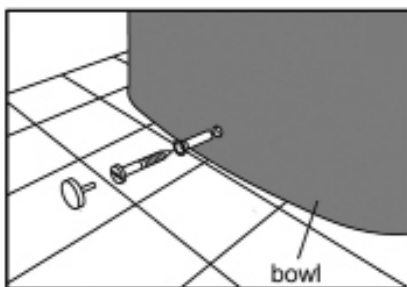
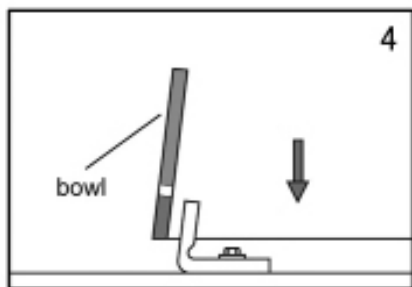
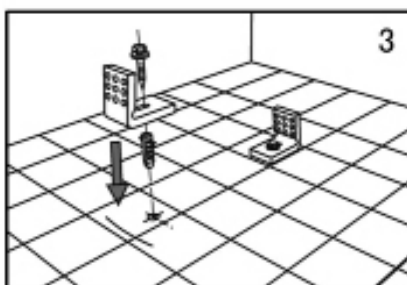
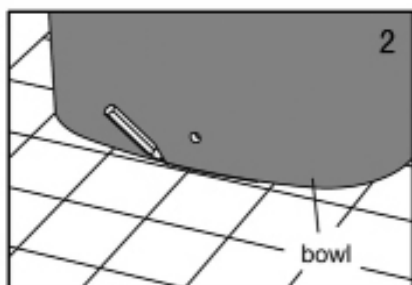
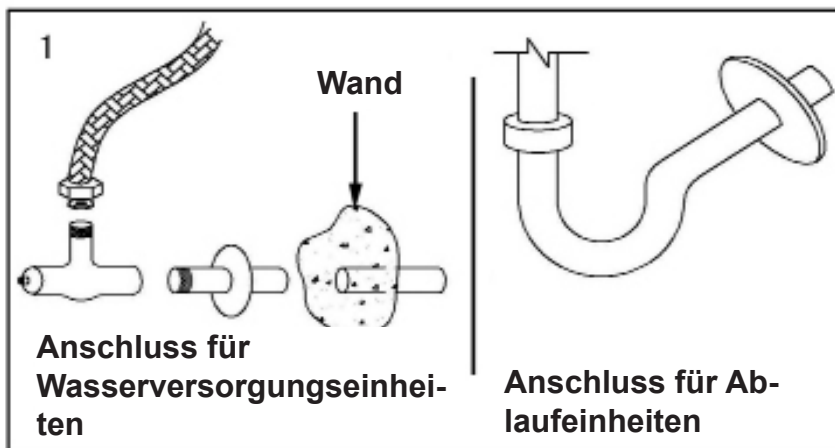

## Avant l'installation

- 1 Assurez-vous que le mur soit droit.
- 2 Lisez les instructions pour vous familiariser avec les outils, et les procédures d'installation et de raccords pour éviter tout dommage inutile.
- 3 Vérifiez que le raccord suive le formulaire de raccordement et vérifiez que votre produit ne soit pas endommagé.
- 4 Étant en céramique et facilement abîmable, manipulez-le avec douceur et l'écrou ne doit pas être trop serré.
- 5 Assurez-vous que l'arrivée d'eau est été fermée.

## Outils (non inclus)



Tournevis plat



Perceuse



Gel de silicone



Clé



Niveau à bulle



Mètre ruban



Crayon

## Procédure d'installation

- 1 Placez le bidet dans une position qui vous convient et alignez la prise d'eau du bidet avec la sortie de drainage.

Remarque: Prévoyez assez de distance pour pouvoir connecter le tuyau d'arrivée d'eau et le tuyau de drainage.

- 2 Marquez les trous d'installation au sol.
- 3 Enlevez le bidet délicatement et percez les trous correspondants aux marques. Insérez le plastique extensible ou installez 7# le plastique fixant.
- 4 Installez le robinet, la valve d'arrivée d'eau et l'unité de drainage en respectant les instructions d'installation pour le raccordement.
- 5 Mettez le bidet dans une position qui vous convient et connectez la valve d'arrivée d'eau et le robinet avec le tuyau souple. Ajustez ensuite la barre de liaison.

Remarque: Le robinet d'eau n'est pas fourni avec ce produit.

- 6 Alignez la vis avec le morceau de plastique et fixez le bidet au sol. Couvrez-la ensuite avec le couvre-vis.
- 7 Enduisez d'une couche de silicone entre le bidet et le sol.
- 8 Finissez l'installation.

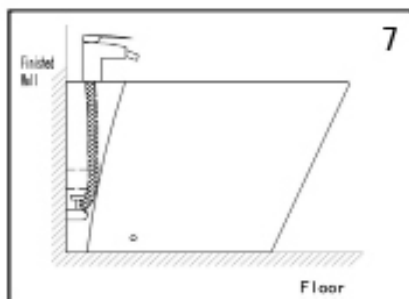
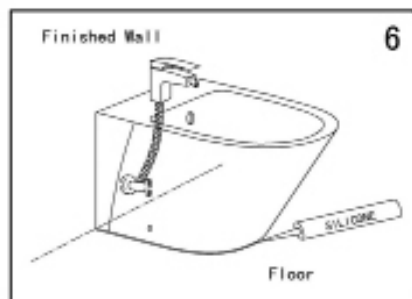
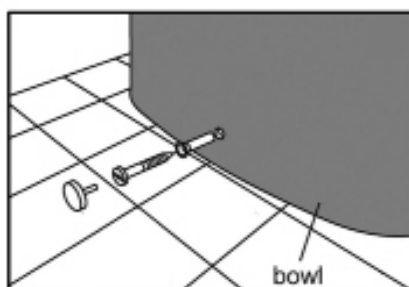
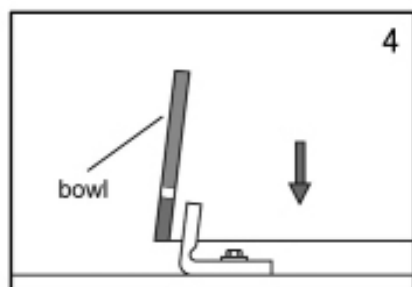
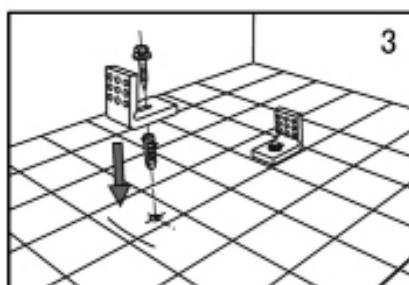
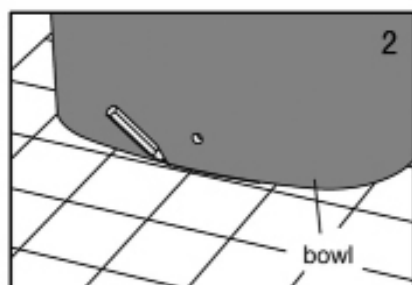
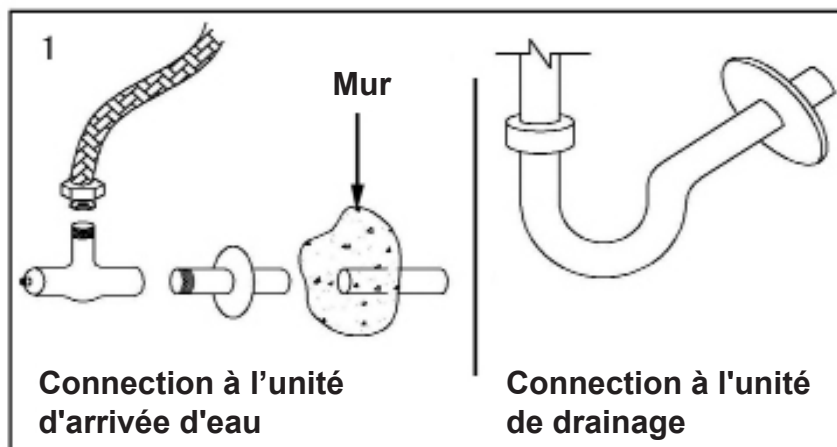

## Összeszerelés előtt

- 1 Győződjön meg arról, hogy a fal egyenes.
- 2 Olvassa el az útmutatót, hogy megismerje a szükséges szerszámokat, szerelvényeket és az összeszerelési folyamatot a nemkívánt káresetek megelőzése érdekében.
- 3 Ellenőrizze, hogy a szerelvények megfelelően illeszkednek-e egymásba, és hogy nem sérült-e meg a termék.
- 4 Mivel a kerámia nagyon sérülékeny, kérjük, bánjon vele óvatosan, és ne húzza túl szorosra az anyákat.
- 5 Győződjön meg róla, hogy a vízvezeték el van zárva.

## Szerszámok (a doboz nem tartalmazza ezeket)



Lapos csavarhúzó



Fúrógép



Szilikongél



Csavarkulcs



Vízszintező



Mérőszalag



Ceruza

## Összeszerelés menete

- 1 Helyezze a bidét a kívánt helyre úgy, hogy a vízvezető nyílása illeszkedjen a szennyvízelvezető kimenettel.

Megjegyzés: Hagyjon elég helyet mind a víz-, mind a szennyvízelvezetőknek.

- 2 Jelölje meg a furatok helyét a padlón.
- 3 Húzza el a bidét, és fúrja meg a lyukakat a jelölések helyén. Helyezze fel a túgulékony műanyagot, vagy szerelje be a 7# rögzítő műanyagot.
- 4 Szerelje fel a csaptelepet, a vízvezetékcsaptelepet és a szennyvízelvezető egységeket az útmutató szerint.
- 5 Helyezze vissza a bidét a helyére, és a rugalmas vezetékkel kösse össze a vízvezetékcsaptelepet illetve a csaptelepet. Majd állítsa be az összekötő szint.

Megjegyzés: A csaptelep nem tartozéka a terméknek.

- 6 Illessze a csavart a műanyagdarabhoz, és rögzítse a bidét a padlóhoz. Majd helyezze fel a díszkupakot.
- 7 Vigyen fel egy réteg szilikont a bidé és a padló közé.
- 8 Ezzel befejeződik a szerelés.

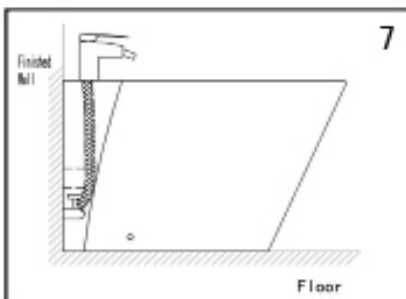
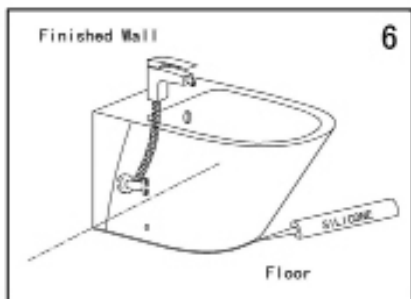
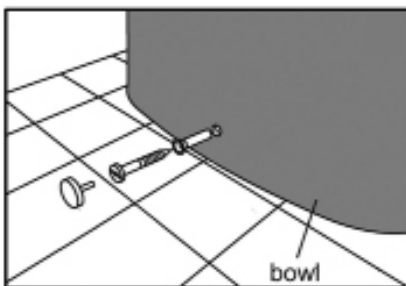
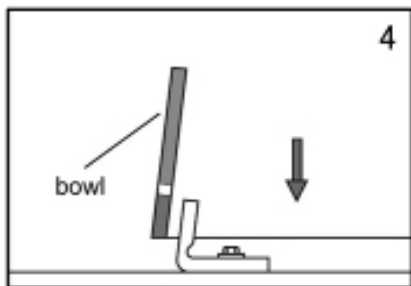
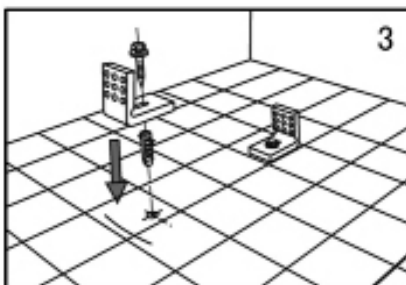
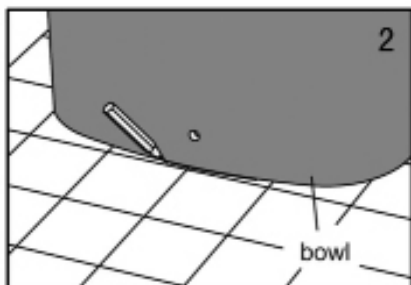
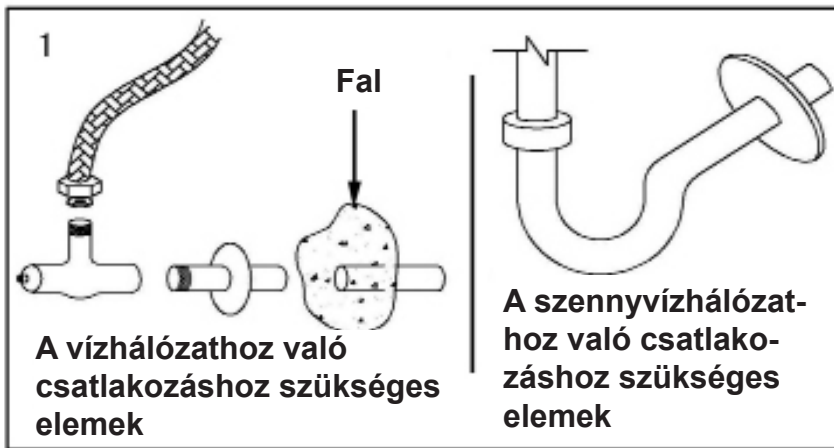

## Înainte de montare

- 1 Asigurați-vă că peretele este drept.
- 2 Citiți instrucțiunile pentru a avea cunoștință de sculele, instalațiile și procedurile de montare de care aveți nevoie pentru prevenirea eventualelor daune.
- 3 Verificați ca piesele să se potrivească bine una în cealaltă și dacă produsul s-a deteriorat.
- 4 Deoarece ceramica este fragilă, manipulați cu grijă și nu strângeți prea tare piulițele.
- 5 Asigurați-vă că alimentarea cu apă este oprită.

## Scule (neincluse în pachet)



Șurubelniță plată



Bormașină



Gel siliconic



Cheie



Nivelă cu bule



Ruletă



Creion

## Procedura de montare

- 1 Așezați bideul în locul dorit, astfel încât orificiul scurgerii să se potrivească la ieșire.

Notă: Lăsați loc suficient pentru conductele de apă și evacuare.

- 2 Marcați locul găurilor pe podea.
- 3 Trageți la o parte bideul și realizați găurile în locul marcajelor. Așezați piesa de plastic flexibilă sau montați piesa de plastic de fixare 7#.
- 4 Montați bateria, ventilul de conductă și unitățile de evacuare conform instrucțiunilor.
- 5 Puneți la loc bideul și conectați cu un furtun flexibil ventilul de apă și bateria. Apoi reglați șinele de legătură.

Notă: Bateria nu este accesoriul produsului.

- 6 Ajustați șurubul la piesa din plastic și fixați bideul de podea. Apoi, montați capul decorativ.
- 7 Aplicați un strat de silicon între bideu și podea.
- 8 Montarea s-a finalizat.

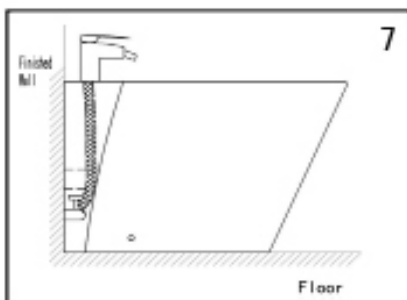
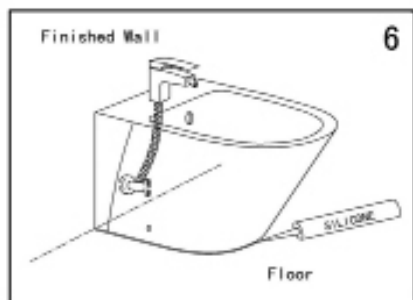
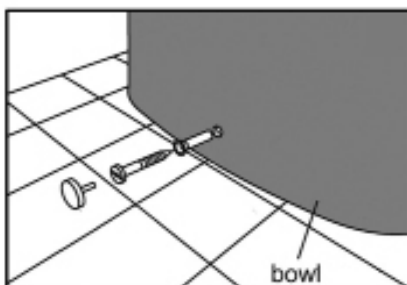
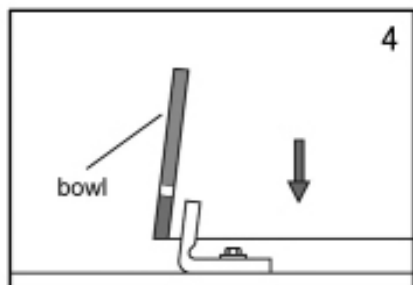
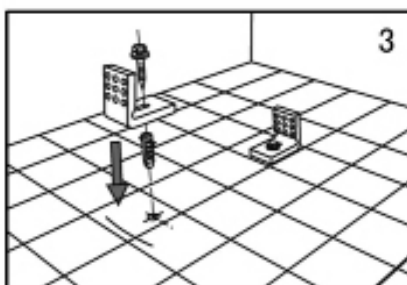
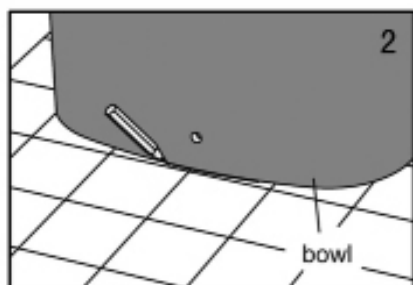
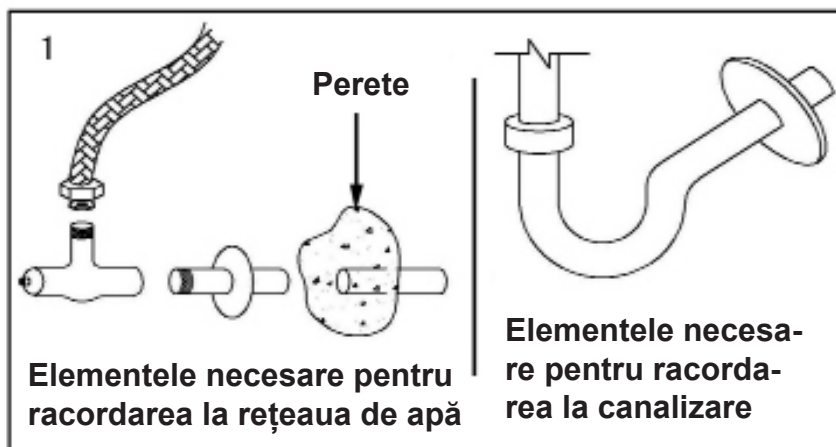

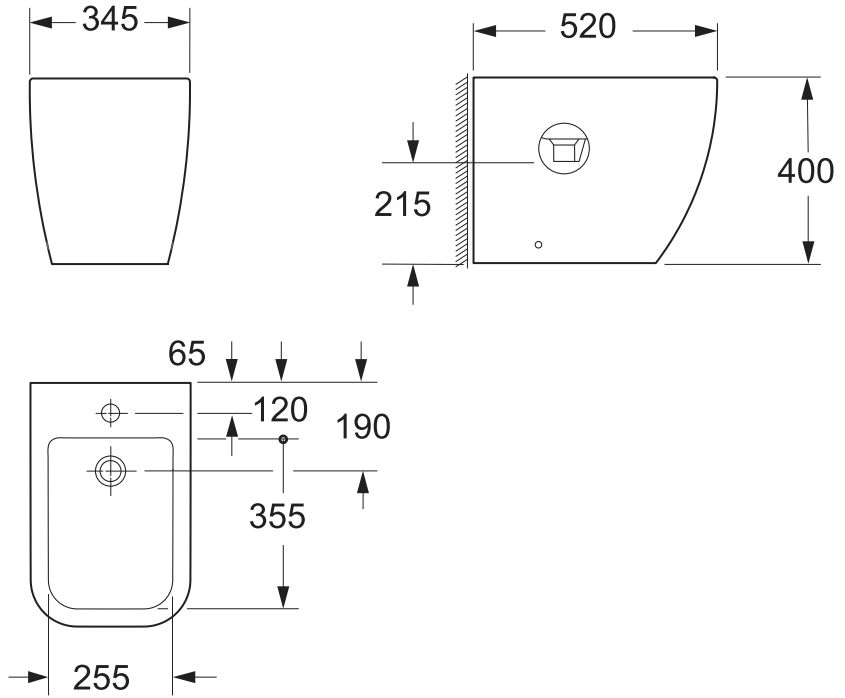

Wellis®

CE