

Wellis®

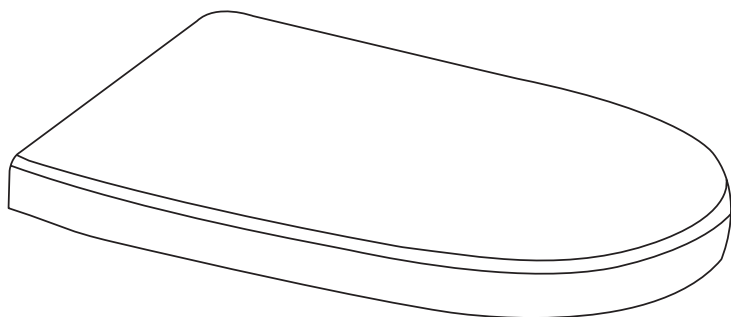

EN

Toilet seat

INSTALLATION MANUAL

HU

WC ülőke

SZERELÉSI ÚTMUTATÓ

DE

Toilettensitz

INSTALLATIONSANLEITUNG

FR

Siège de toilette

INSTALLATION MANUELLE

RO

Capac WC

INSTRUCȚIUNI DE MONTARE

TOILET SEAT

1、 BEFORE INSTALLATION

- Please read the instructions carefully, get to know our seats and get prepared with the required tool in advance. Follow the instructions to install the seat correctly. This will help avoiding harming you and your family and your property.
- Please keep the instructions available after reading it carefully.
- Please subject to the real products when the instructions are different from the real products. If there is any new update to products and its accessories, we will give no further notice.

2、 MAINTENANCE

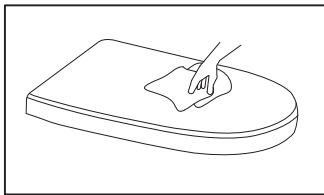

- Regular Maintenance
 - Wipe the toilet seat with soft wet cloth.
 - Clean the toilet seat with neutral cleanser, and then dry it with clean cloth.

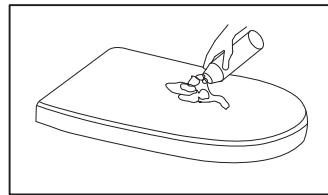

- Eradicator
 - Don't clean the toilet seat with lapping powder.
 - Don't use any disinfectant, eradicator or spraying cleanser.
 - Keep the toilet seat away from chemicals and cosmetics.

3、 CAUTIONS

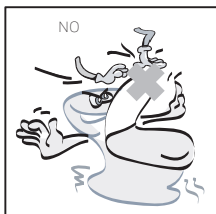

Please do not close the seat or cover forcibly to extend the soft-close function lifespan.

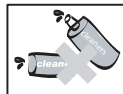

Please do not clean the seat or cover with strong chemical cleaners or rigid brushes. (to avoid harming the seat & cover)



Please do not place heavy objects on the cover. Please avoid sitting forcefully and suddenly on the seat or cover. (to avoid making the seat & cover break)



Please do not expose the seat or cover to direct sunlight for too long. Avoid any direct strong light or high temperature. (to avoid making seat & cover fade)

4. INSTALLATION INSTRUCTION OF DIFFERENT HINGES (PLEASE CHOOSE THE RIGHT HINGE)

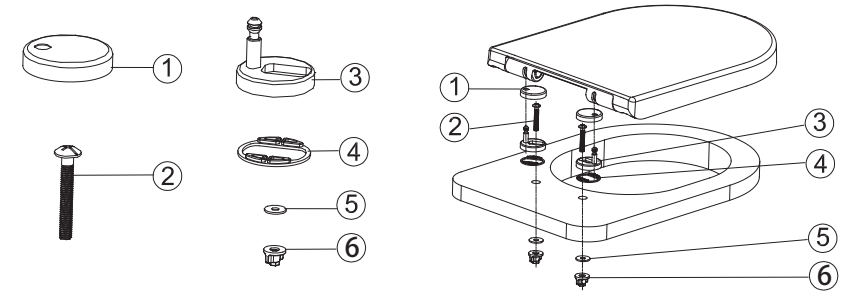
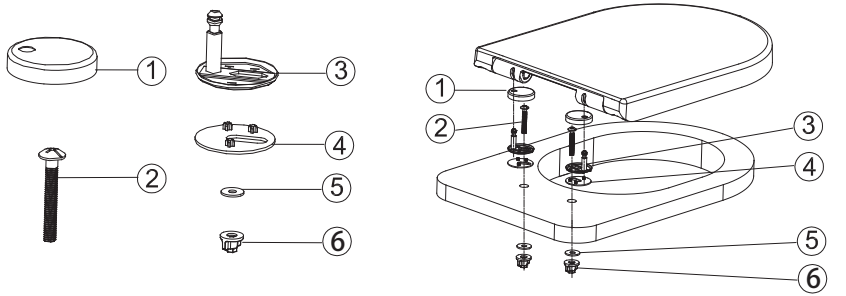
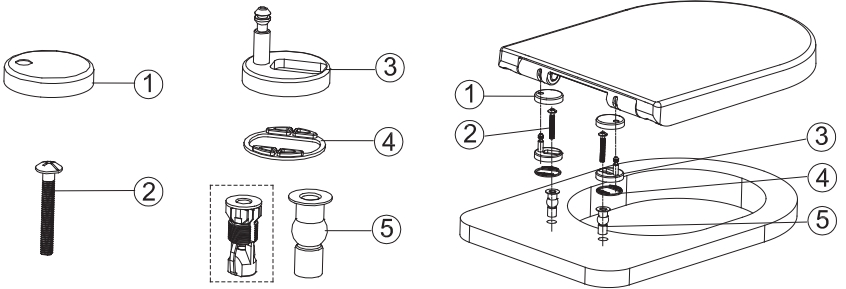
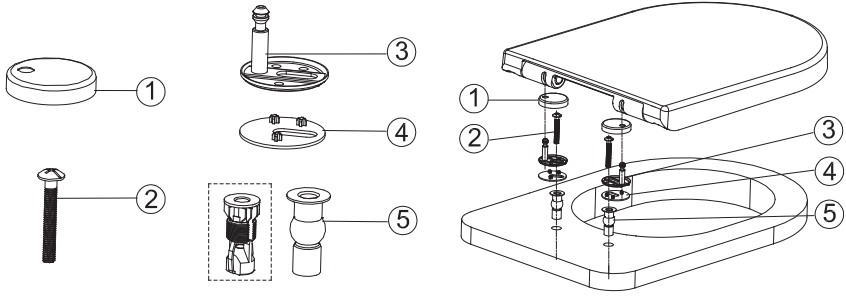

5. INSTALLATION

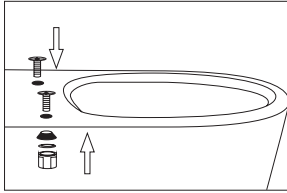

1). Put the plastic screws into the holes on the toilet pan and tighten them below by nuts.

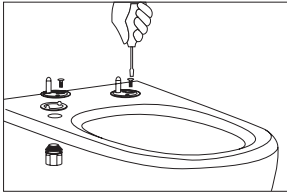

2). Put the hinge gasket below the stainless steel hinge base and make the stainless steel screws into the holes of the base and gasket and screw them. (Attention: Don't screw too much in order to adjust the seat cover conveniently)

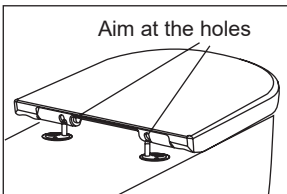

3). Aim at the holes and adjust the hinge base to make the seat cover and pan match. Take out the seat cover once the installation position is confirmed.

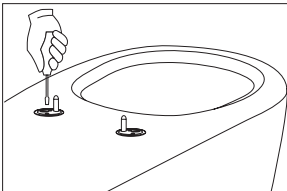

4). Fix the hinge base on the pan firmly.

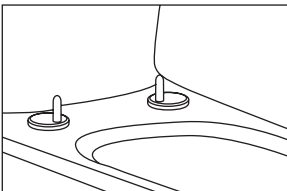

5). Put the cap into the hinge base.

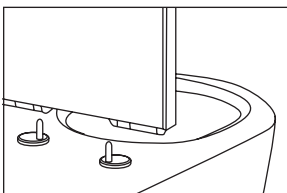

6). Fix the seat cover into the hinge base.

1. VOR DER INSTALLATION

- Bitte lesen Sie die Anleitung sorgfältig, lernen Sie unsere Sitze kennen und bereiten Sie sich mit den erforderlichen Werkzeugen vor. Folgen Sie den Anleitungen, um den Sitz korrekt zu installieren. Das hilft dabei, dass Sie sich, Ihrer Familie und Ihrem Eigentum keinen Schaden zufügen.
- Bitte bewahren Sie die Anleitung auf, nachdem sie sie sorgfältig gelesen haben
- Bitte stützen Sie sich auf die echten Produkte, wenn die Anleitung von den echten Produkten abweicht. Wenn es neue Aktualisierungen der Produkte und dessen Zubehör gibt, werden darüber keine Nachrichten verschickt.

2. PFLEGE

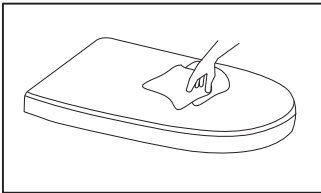

Normale Pflege

- Wischen Sie den Toilettensitz mit weichem, nassen Stoff ab.
- Säubern Sie den Toilettensitz mit neutralem Reiniger und trocknen Sie ihn dann mit sauberem Stoff.

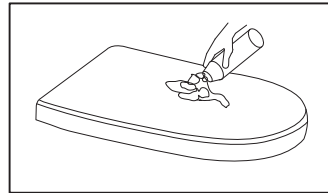

Ausrottungsmittel

- Säubern Sie den Toilettensitz mit Lappulver
- Nutzen Sie keine Desinfektionsmittel oder Sprühreiniger
- Halten Sie den Toilettensitz frei von Chemikalien und Kosmetiken

3. ACHTUNG



Bitte schließen Sie den Sitz oder die Klappe nicht mit Gewalt, um die Lebensdauer der Selbstschließfunktion zu verlängern.

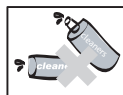

Bitte säubern Sie den Sitz oder die Abdeckung nicht mit starken chemischen Reinigern oder kratzigen Bürsten (um Schäden am Sitz und der Abdeckung zu vermeiden)



Bitte legen Sie keine schweren Objekte auf der Abdeckung ab. Bitte vermeiden Sie es sich absichtlich und plötzlich auf den Sitz oder die Abdeckung zu setzen (um zu vermeiden, dass der Sitz & die Abdeckung kaputt gehen)



Bitte setzen Sie den Sitz oder die Abdeckung nicht zu lange direktem Sonnenlicht aus. Vermeiden Sie jedes starke Licht oder hohe Temperatur (um zu vermeiden, dass der Sitz und die Abdeckung nicht verbleicht).

4. Installationsanleitung verschiedener Scharniere (bitte richtiges Scharnier wählen)

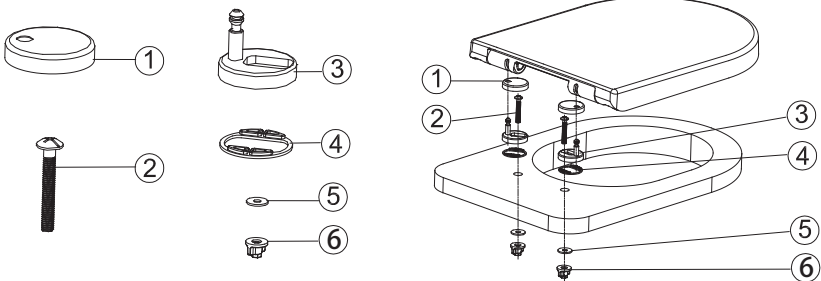
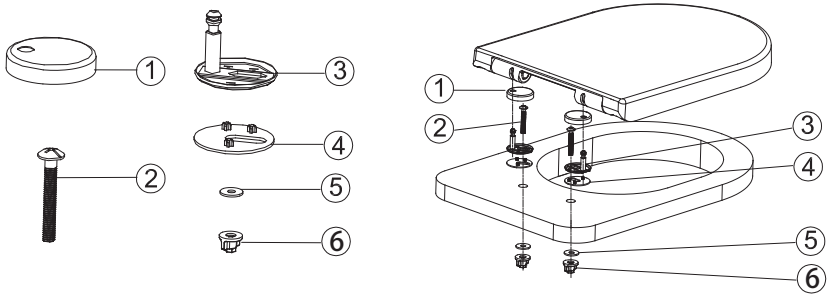
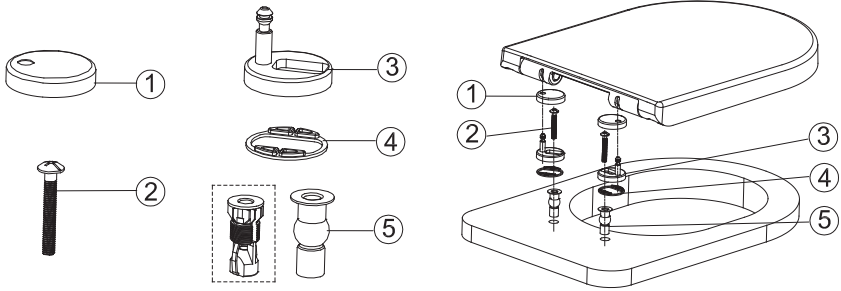
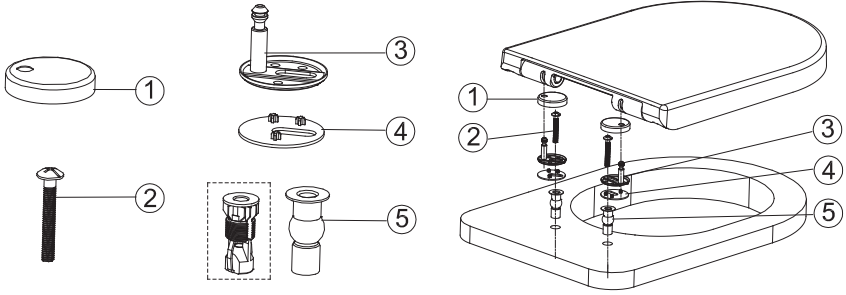

5. INSTALLATION

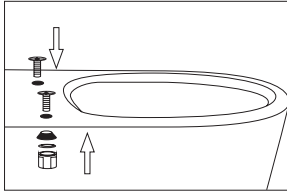

1). Stecken Sie die Kunststoffschrauben in die Löcher der Toilettenschüssel und ziehen Sie sie unten mit Muttern fest.

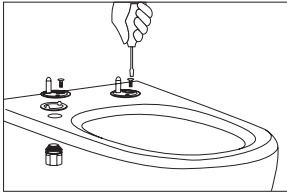

2). Legen Sie die Scharnierdichtung unter den Edelstahlfuß und bringen Sie die Edelstahlschrauben in die Löcher des Sockels und der Dichtung und schrauben Sie sie fest. (Achtung: Schrauben Sie nicht zu viel, um den Sitzbedeckung bequem einzustellen.

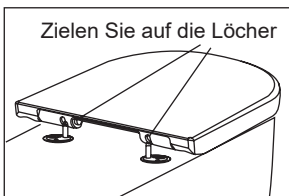

3). Richten Sie die Bohrungen aus und stellen Sie die Scharnierbasis so ein, dass Sitzbezug und Pfanne zusammenpassen. Nehmen Sie den Sitzbedeckung heraus, sobald die Montageposition bestätigt ist.

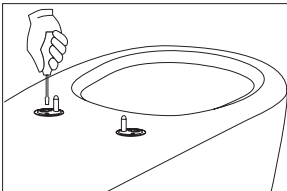

4). Befestigen Sie den Scharniersockel fest auf der Schüssel.

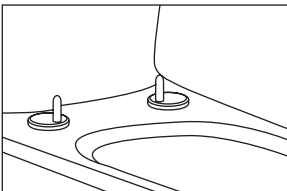

5). Setzen Sie die Kappe in die Grundfläche.

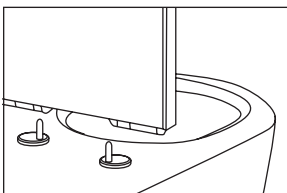

6). Befestigen Sie die Sitzbedeckung im Scharniersockel.

1. Avant l'installation

- Veuillez lire les instructions attentivement, ayez plus d'informations sur nos sièges et préparez les outils nécessaires
- À l'avance. Suivez les instructions pour installer le siège correctement. Cela permettra d'éviter les risques à vous et votre famille et vos biens.
- Veuillez conserver les instructions disponibles après les avoir lus attentivement.
- Veuillez vous soumettre aux produits réels lorsque les instructions sont différentes des produits réels. S'il y a une nouvelle mise à jour de produits et de ses accessoires, nous ne donnerons aucun avis.

2. Entretien

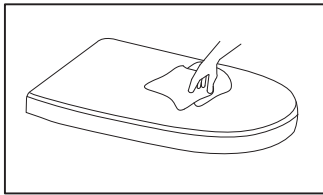

- L'entretien régulier
- Nettoyez le siège de la toilette avec un tissu humide.
- Nettoyez le siège de la toilette avec un nettoyant neutre, puis séchez-le avec un tissu propre.

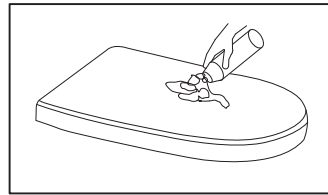

- Effaceur
- Ne nettoyez pas le siège de la toilette avec une poudre de polissage
- N'utilisez aucun désinfectant, Effaceur ou spray nettoyant
- Gardez le siège de la toilette loin des produits chimiques et cosmétiques

3. Mise en garde

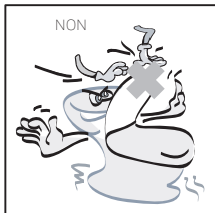

Veuillez ne pas fermer le siège ou le capot avec force afin de prolonger la durée de l'amortissement intégré.

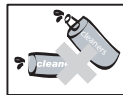

Veuillez ne pas nettoyer le siège ou le capot avec un nettoyant chimique fort ou des pinces rigides. (Pour éviter de nuire au siège & au capot)



Veuillez ne pas placer des objets lourds sur le capot. Veuillez éviter de s'asseoir avec force et soudainement sur le siège ou le capot. (Pour éviter de casser le siège & le capot)



Veuillez ne pas exposer le siège ou le capot directement aux rayons du soleil pendant trop longtemps. Évitez toute lumière forte directe ou haute température. (Pour éviter de fondre le siège et le capot)

4. Instructions d'installation sur différentes charnières (veillez a choisir les bonnes charnières)

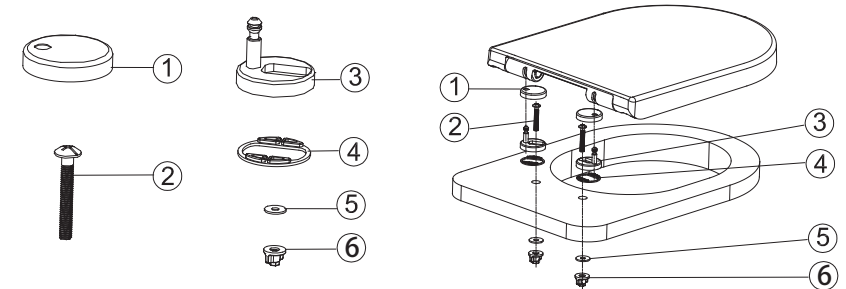
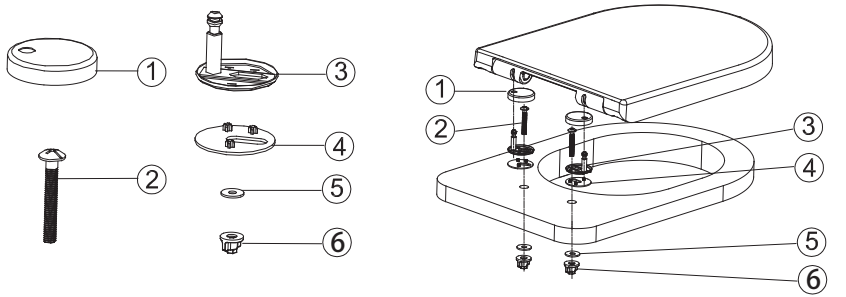
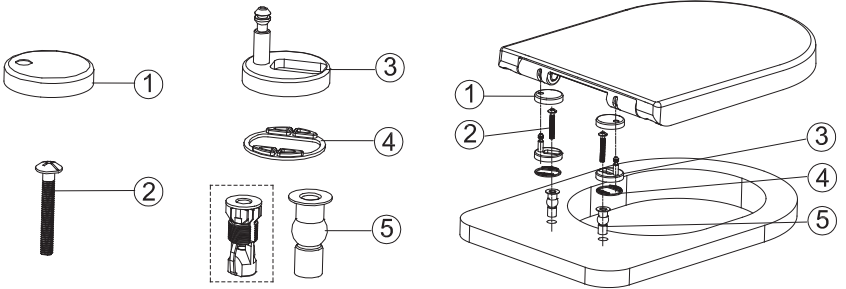
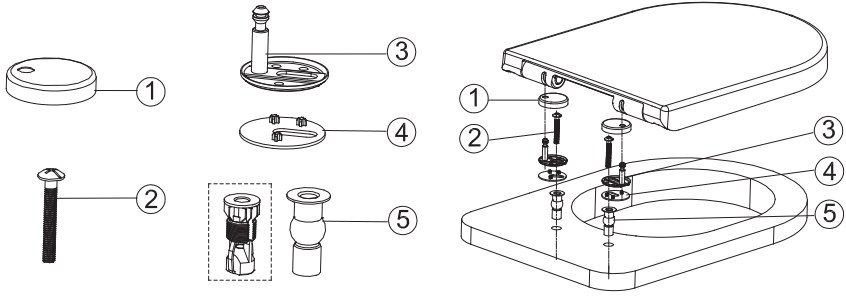

5. Installation

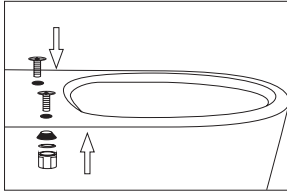

1). Placez les vis en plastique dans les trous de la cuvette des toilettes et serrez-les avec des écrous.

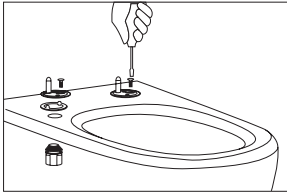

2). Placez le joint de charnière sous la base en acier inoxydable et vissez les vis en acier inoxydable dans les trous de la base et du joint et vissez-les. (Attention: Ne vissez pas trop pour pouvoir régler l'abattant du siège de manière pratique)

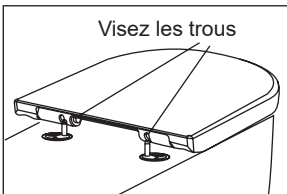

3). Visez les trous et ajustez la base de la charnière pour faire correspondre l'abattant du siège et la cuvette. Retirez l'abattant du siège une fois que la position d'installation est confirmée.

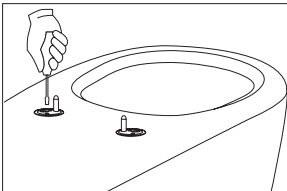

4). Fixez la base de la charnière sur la cuvette fermement.

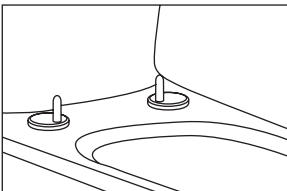

5). Placez le capuchon dans la base de la charnière.

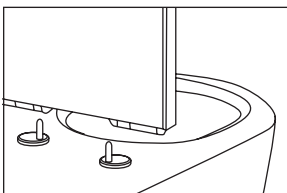

6). Fixez l'abattant du siège à la base de la charnière.

1. SZERELÉS ELŐTT

- Kérjük, olvassa el figyelmesen az útmutatót, hogy megismerje az ülőkéket és előre készítse elő a szükséges eszközöket! Kövesse az útmutatásokat az ülőke megfelelő felszerelése érdekében! Ez segít abban, hogy elkerülje a sérüléseket és tárgyi károkat.
- Kérjük, tegye elérhető helyre az útmutatót miután azt figyelmesen elolvasta!
- Kérjük, igazítsa hozzá az útmutatót a saját termékre, ha az útmutató különbözik a termékétől! Ha van bármilyen újítás a termékben vagy a kiegészítő eszközökben, akkor semmilyen további információval nem szolgálunk.

2. KARBANTARTÁS

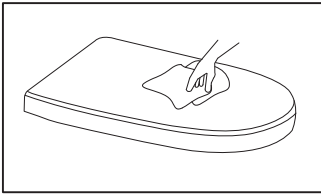

Hagyományos karbantartás

- Törölje le a WC ülőkét puha nedves ruhával!
- Tisztítsa az ülőkét semleges tisztítóval és tiszta ruhával törölje szárazra!

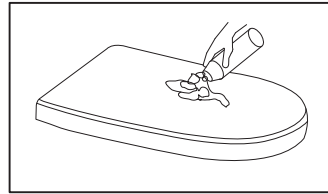

Folttisztító

- Ne tisztítsa a WC ülőkét csiszoló porral!
- Ne használjon fertőtlenítőt, folttisztítót vagy spray tisztítót!
- Kerülje a vegyszereket és kozmetikai szereket!

3. VIGYÁZAT

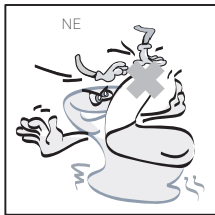

Kérjük ne zárja le a WC ülőkét vagy fedőlapot erővel, mert így lényegesen meghosszabbíthatja azok életidejét!



Kérjük, ne tisztítsa az ülőkét vagy a fedőlapot erős vegyi tisztítóval vagy kemény kefével (kerülje az ülőke felületének megsérülését)!



Kérjük, ne helyezzen súlyos tárgyakat a fedőlapra! Ne üljön rá erőszakosan és hirtelen az ülőkére vagy a fedőlapra (kerülje el az ülőke vagy fedőlap törését)!



Kérjük, ne tegye ki túl sokáig az ülőkét vagy a fedőlapot közvetlen napfénynek! Kerülje az erős fényt vagy magas hőmérsékletet (kerülje el az ülőke vagy a fedőlap kifakulását)!

**4. KÜLÖNBÖZŐ CSUKLÓSZERKEZETEK ÖSSZESZERELÉSI ÚTMUTATÓI
(KÉREM, A MEGFELELŐ CSUKLÓT VÁlassZA!)**

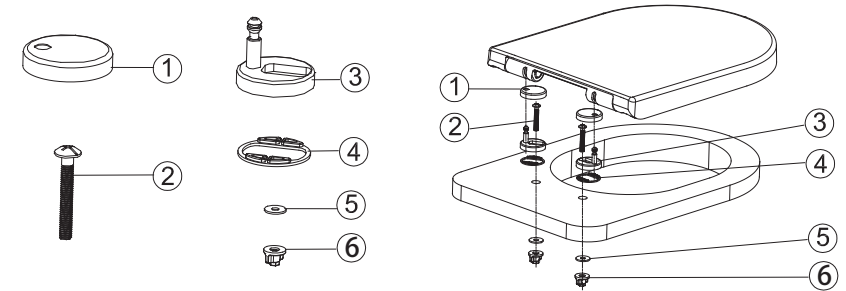
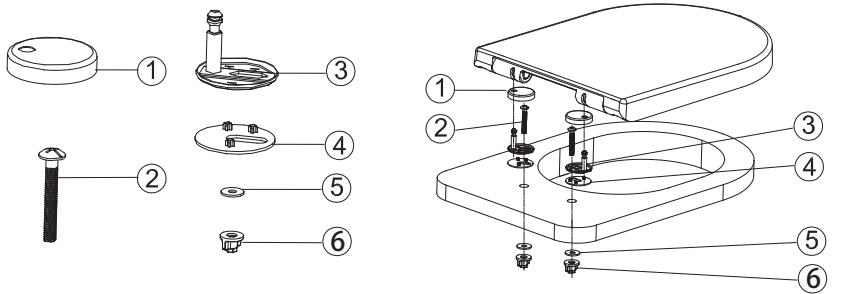
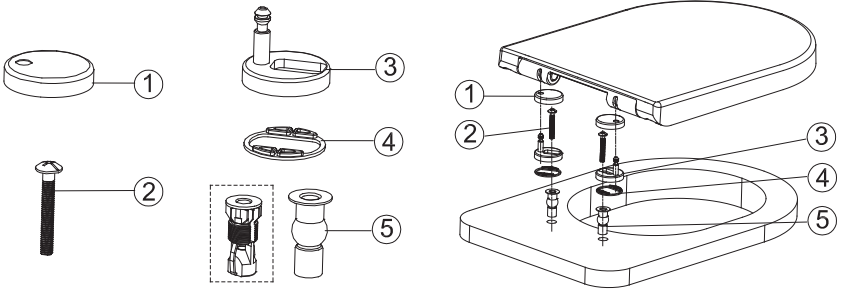
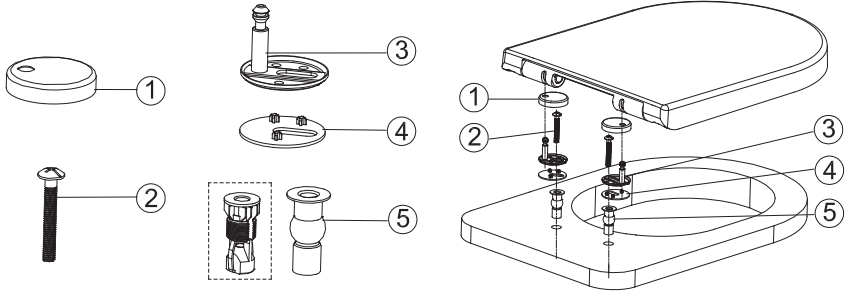

5. FELSZERELÉS

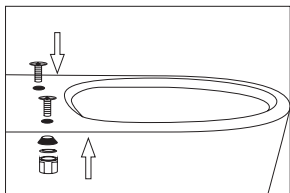

1). Helyezze a műanyag csavarokat a vécécsészén található lyukakba és rögzítse őket alul egy anyával.

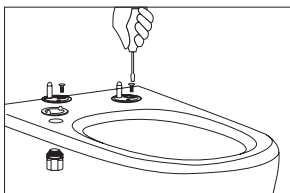

2). Helyezze a tömítéseket a rozsdamentes acél sarokvasak alá és helyezze a tömítés aljába a rozsdamentes acél csavarokat, majd csavarozza be őket. (Figyelem: Ne csavarozza be őket túl szorosan annak érdekében, hogy az ülőke fedelét kényelmesen be tudja állítani)

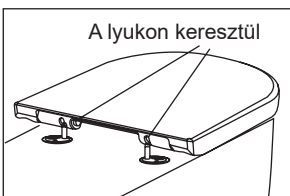

3). Igazítsa a lyukakat és a tömítés alapot úgy, hogy az ülőke fedele és a csésze jól illeszkedjenek. Vegye ki az ülőke fedelét, amikor meghatározta a felszerelés pontos helyét.

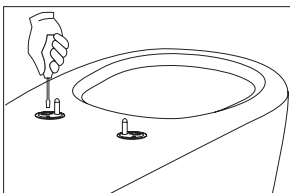

4). Rögzítse szorosan a tömítés alapot a csészéhez.

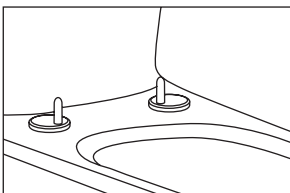

5). Helyezze a fedelet a tömítésbe.

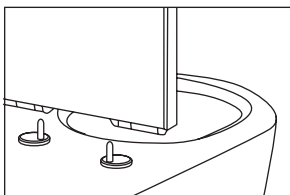

6). Rögzítse az ülőke fedelét a tömítésbe.

1. ÎNAINTE DE MONTARE

- Vă rugăm să citiți cu atenție instrucțiunile pentru a cunoaște capacul și pentru a pregăti sculele necesare! Respectați instrucțiunile în vederea montării corecte a capacului! Acest lucru ajută la evitarea rănilor și a pagubelor materiale.
- Țineți instrucțiunile într-un loc accesibil după ce l-ați citit cu atenție!
- Adaptați instrucțiunile la produsul achiziționat în cazul în care acesta diferă de produs! Dacă există elemente noi în produs sau accesorii, nu oferim nicio informație suplimentară.

2. ÎNTREȚINERE

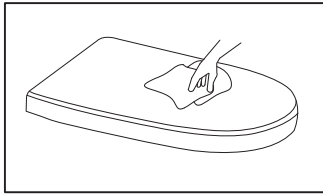

Întreținere obișnuită

- Ștergeți capacul WC cu o lavetă umedă și moale!
- Curățați capacul cu un detergent neutru și uscați-l ștergând cu o lavetă uscată!

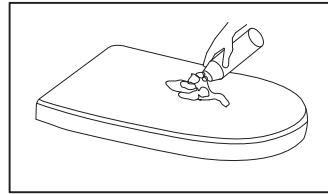

Soluție pentru îndepărtarea petelor

- Nu curățați capacul WC cu prafuri abrazive!
- Nu folosiți dezinfectanți, soluții pentru îndepărtarea petelor sau soluții spray!
- Evitați utilizarea substanțelor chimice și a cosmeticilor!

3. ATENȚIE



Nu închideți colacul sau capacul cu putere, astfel puteți prelungi considerabil durata de viață a acestora!



Nu curățați colacul sau capacul cu substanțe chimice agresive sau cu perii tari (evitați deteriorarea colacului)!



Nu puneți obiecte grele pe capac! Nu vă așezați brusc și tare pe colac sau capac (evitați spargerea colacului sau a capacului)!



Nu expuneți colacul sau capacul timp îndelungat la razele solare directe! Evitați expunerea la lumină puternică și temperaturi înalte (evitați decolorarea colacului sau a capacului)!

**4. INSTRUCȚIUNI DE MONTARE PENTRU DIVERSE STRUCTURI DE ARTICULAȚII
(ALEGEȚI ARTICULAȚIILE CORESPUNZĂTOARE!)**

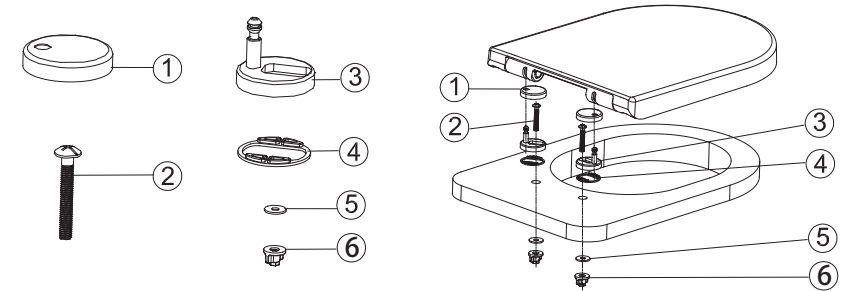
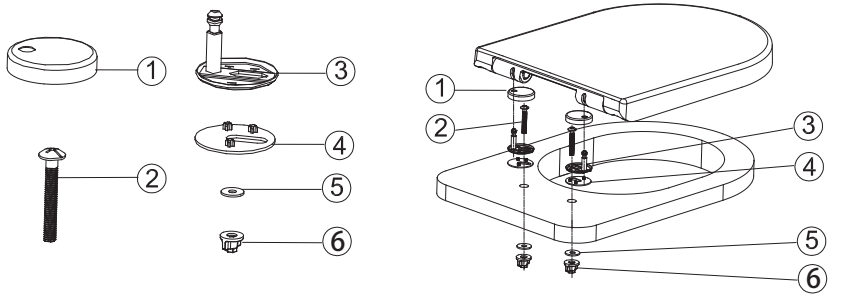
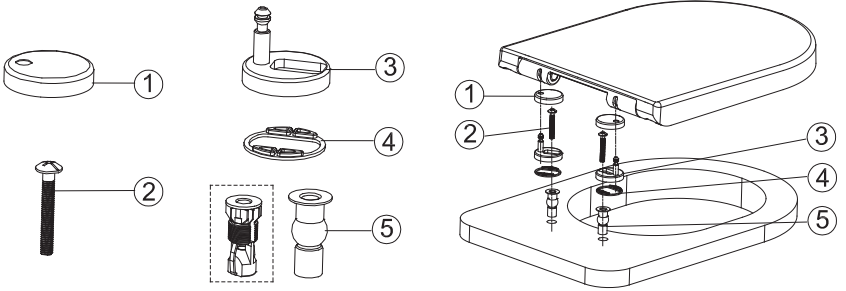
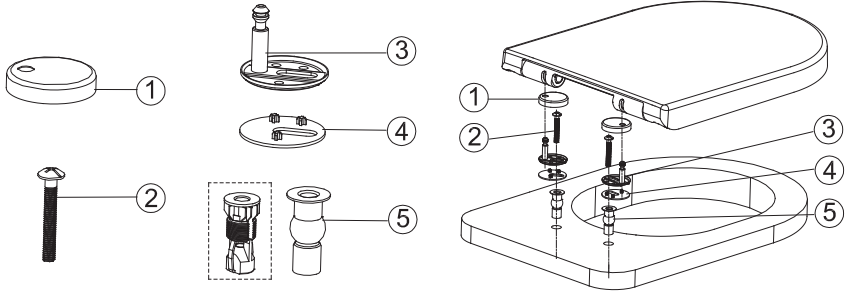

5. MONTAREA

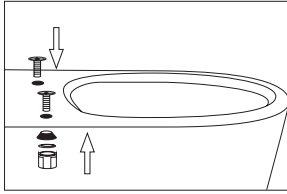

1). Introduceți șuruburile din plastic în orificiile de pe vasul WC și fixați-le în partea inferioară cu piulițe.

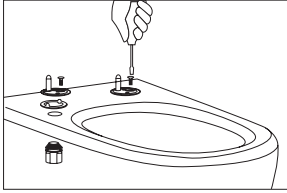

2). Așezați garniturile sub balamalele inoxidabile, introduceți în partea inferioară a garniturilor șuruburile din oțel inoxidabil, apoi înșurubați-le. (Atenție: Nu strângeți prea tare șuruburile pentru a putea regla ușor capacul vasului WC)

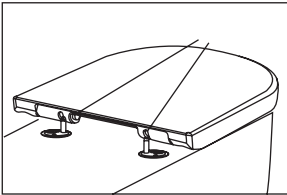

3). Reglați orificiile și baza garniturilor astfel încât capacul WC și vasul să se potrivească. Scoateți capacul WC dacă ați stabilit locul exact de montare.

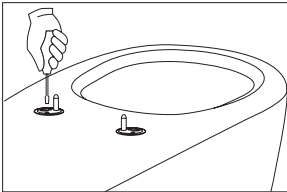

4). Fixați strâns baza garniturii de vas.

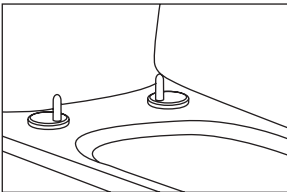

5). Așezați capacul pe garnitură.

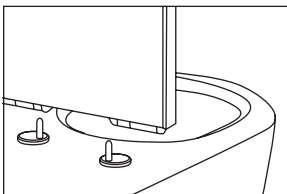

6). Fixați capacul pe garnitură.

Wellis®

Bella

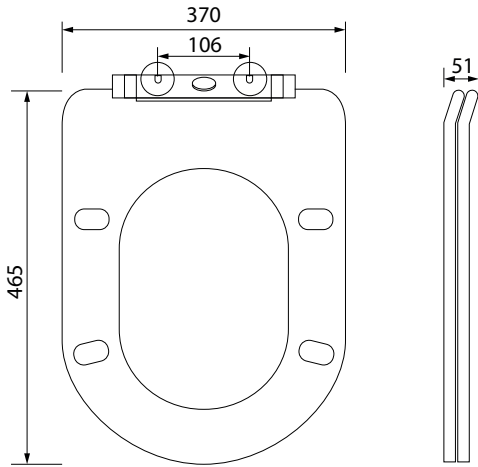

Elle

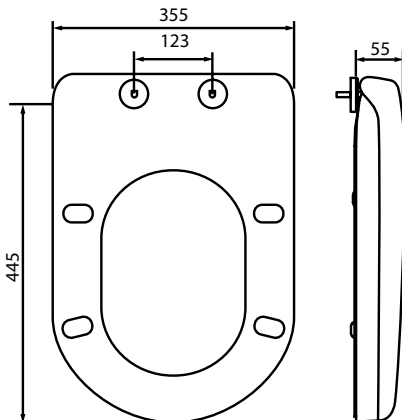

Wellis®

Erin

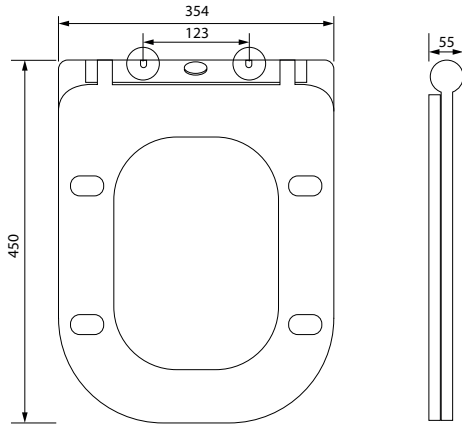

Ditte

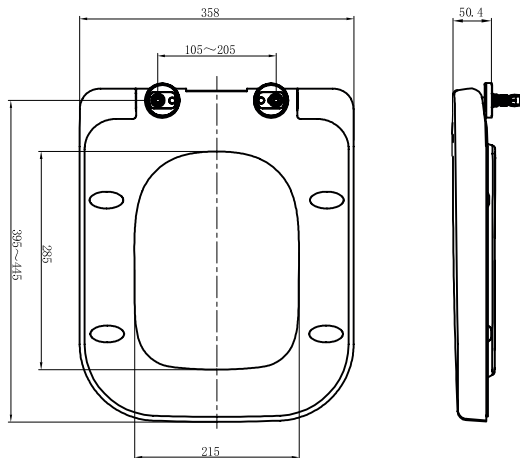

Andreas „A” Andreas „B”

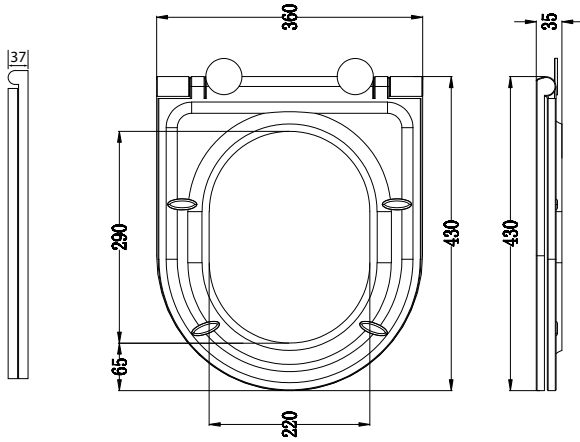
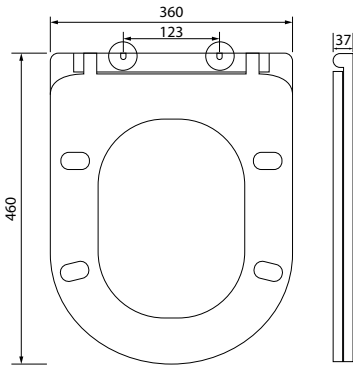

Clement

black

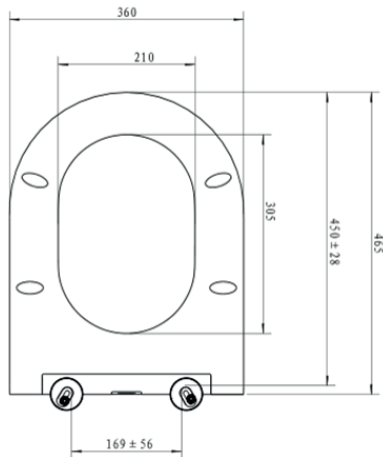

Aurora

WF00183;

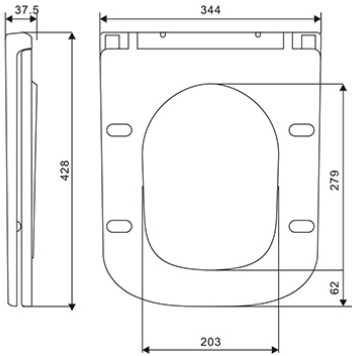

WF00186

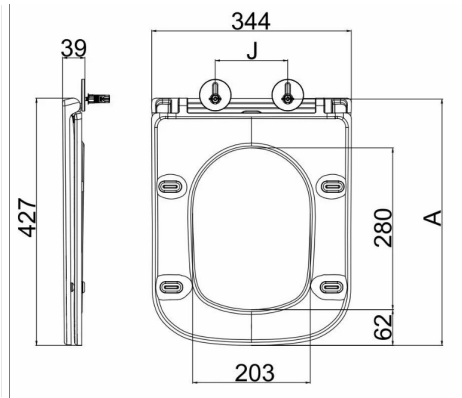

WF00184

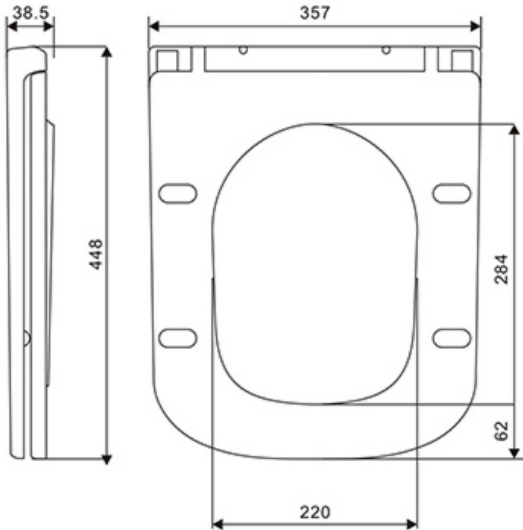

Wellis®
CE